

Dell™ Vostro™ V13

Setup and Features Information

Front View

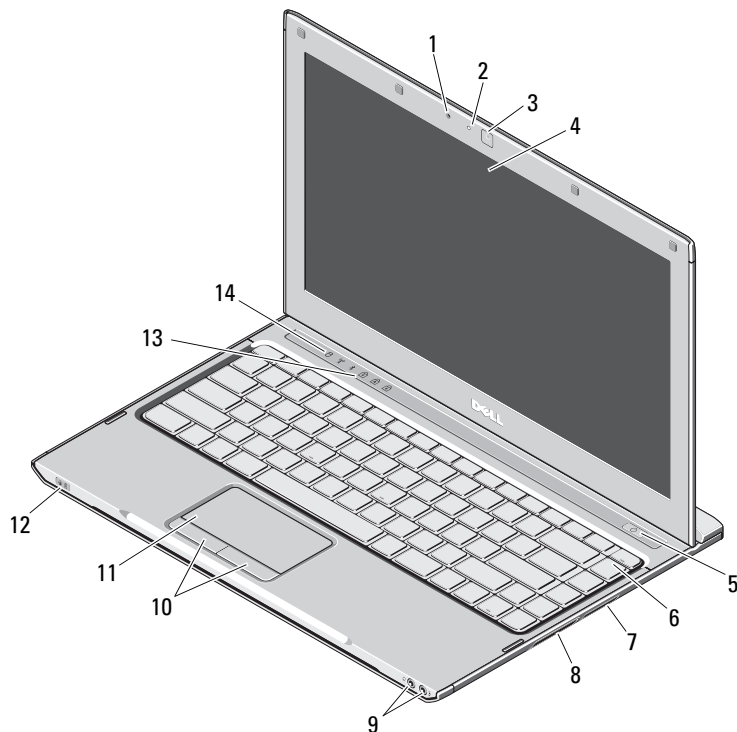

About Warnings



WARNING: A WARNING indicates a potential for property damage, personal injury, or death.

- 1 microphone
- 2 camera status light
- 3 camera
- 4 display
- 5 power button
- 6 keyboard
- 7 5-in-1 media card reader
- 8 ExpressCard slot
- 9 audio connectors (2)
- 10 touchpad buttons (2)
- 11 touchpad
- 12 power/battery status indicators
- 13 keyboard status lights
- 14 device status lights



Regulatory Model: P08S

Regulatory Type: P08S001

October 2009



OYK2KYA00

Back View

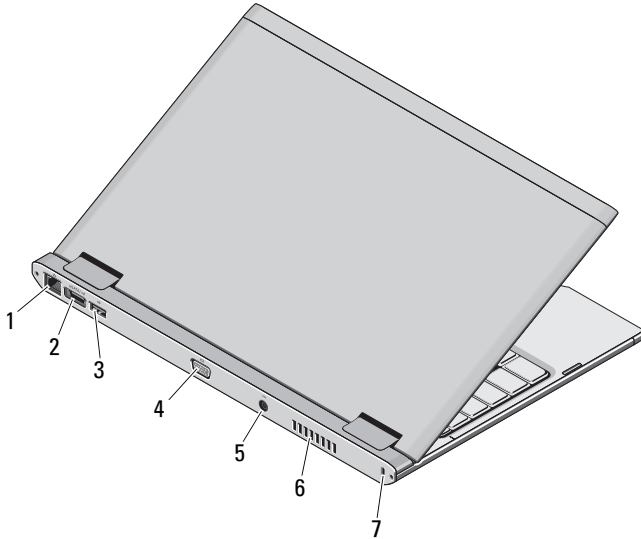

- 1 network connector
- 2 eSATA/USB connector
- 3 USB connector
- 4 video connector
- 5 AC adapter connector
- 6 cooling vent
- 7 security cable slot



WARNING: Do not block, push objects into, or allow dust to accumulate in the air vents. Do not store your Dell computer in a low-airflow environment, such as a closed briefcase, while it is running. Restricting the airflow can damage the computer or cause a fire. The computer turns on the fan when the computer gets hot. Fan noise is normal and does not indicate a problem with the fan or the computer.

Quick Setup



WARNING: Before you begin any of the procedures in this section, read the safety information that shipped with your computer. For additional best practices information, see www.dell.com/regulatory_compliance.



WARNING: The AC adapter works with electrical outlets worldwide. However, power connectors and power strips vary among countries. Using an incompatible cable or improperly connecting the cable to the power strip or electrical outlet may cause fire or equipment damage.



CAUTION: When you disconnect the AC adapter cable from the computer, grasp the connector, not the cable itself, and pull firmly but gently to avoid damaging the cable. When you wrap the AC adapter cable, ensure that you follow the angle of the connector on the AC adapter to avoid damaging the cable.



NOTE: Some devices may not be included if you did not order them.

1

Connect the AC adapter to the AC adapter connector on the portable computer and to the electrical outlet.

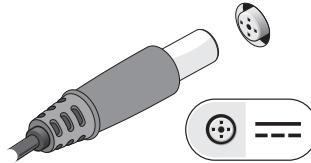

2

Connect the network cable (optional).

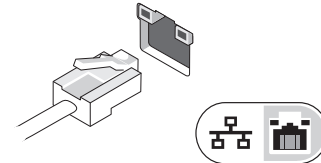

3

Connect USB devices, such as a mouse or keyboard (optional).

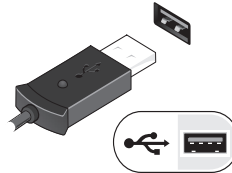

4

Open the computer display and press the power button to turn on the computer.

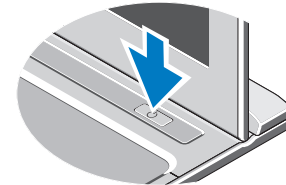

NOTE: It is recommended that you turn on and shut down your computer at least once before you install any cards or connect the computer to a docking device or other external device, such as a printer.

Specifications

 **NOTE:** Offerings may vary by region. For more information regarding the configuration of your computer, click **Start**→**Help and Support** and select the option to view information about your computer.

System Information

Processor type	Intel® Core™2 Solo Ultra Low Voltage (ULV), Intel Core2 Duo ULV, or Intel Celeron® ULV
Chipset	Mobile Intel GS45 Express Chipset

Memory

Memory module connector	one SODIMM slot
Memory module capacity	1 GB, 2 GB, or 4 GB
Memory type	1067 MHz DDR3
Minimum memory	1 GB
Maximum memory	4 GB

Video

Video type	integrated video on the system board
Video controller	Intel GMA X4500HD

Battery

Type	6-cell "smart" lithium-ion (30 WHr)
Dimensions	
Depth	155.20 mm (6.11 inches)

Battery (continued)

Height	5.35 mm (0.21 inches)
Width	177.60 mm (6.99 inches)
Weight	265 +/- 6 gms (0.58 +/- 0.01 lbs)
Voltage	11.1 VDC
Temperature range	
Operating	0° to 35°C (32° to 95°F)
Storage	-40° to 65°C (-40° to 149°F)
Coin-cell battery	3 V CR2032 lithium

AC Adapter

Input voltage	100–240 VAC
Input current (maximum)	1.5 A
Input frequency	50–60 Hz
Output power	65 W
Output current	4.34 A (maximum at 4-second pulse) 3.34 A (continuous)
Rated output voltage	19.5 +/- 1.0 VDC
Dimensions	
Height	16 mm (0.63 inches)
Width	66 mm (2.60 inches)
Depth	127 mm (5.00 inches)

AC Adapter (continued)

Temperature range

Operating	0° to 35°C (32° to 95°F)
Storage	-40° to 65°C (-40° to 149°F)

Physical

Height	18.7 mm (0.74 inches)
Width	330 mm (12.99 inches)
Depth	230 mm (9.05 inches)
Weight	<1.6 kg (<3.53 lbs) (with 6-cell battery)

Environmental

Temperature range

Operating	0° to 35°C (32° to 95°F)
Storage	-40° to 65°C (-40° to 149°F)

Relative humidity (maximum)

Operating	10% – 90% (noncondensing)
Storage	5% – 95% (noncondensing)

Altitude (maximum)

Operating	-15.2 to 3048 m (-50 to 10,000 ft)
Storage	-15.2 to 10,668 m (-50 to 35,000 ft)

Finding More Information and Resources

See the safety and regulatory documents that shipped with your computer and the regulatory compliance website at www.dell.com/regulatory_compliance for more information on:

- Safety best practices
- Warranty
- Terms and Conditions
- Regulatory certification
- Ergonomics
- End User License Agreement

**Information in this document is subject to change without notice.
© 2009 Dell Inc. All rights reserved. Printed in China.
Printed on recycled paper.**

Reproduction of these materials in any manner whatsoever without the written permission of Dell Inc. is strictly forbidden.

Trademarks used in this text: *Dell*, the *DELL logo*, and *Vostro* are trademarks of Dell Inc.; *Intel* and *Celeron* are registered trademarks and *Core* is a trademark of Intel Corporation in the U.S. and other countries.

Other trademarks and trade names may be used in this document to refer to either the entities claiming the marks and names or their products. Dell Inc. disclaims any proprietary interest in trademarks and trade names other than its own.

